

FlexiSpot

MASSAGE CHAIR OE100/OE101/OE102 Instruction Manual

SAVE THESE INSTRUCTIONS

Website: www.flexispot.com

Tel: 1-855 -585 -5618

Address: 6475 Las Positas Rd. Livermore, CA 94551

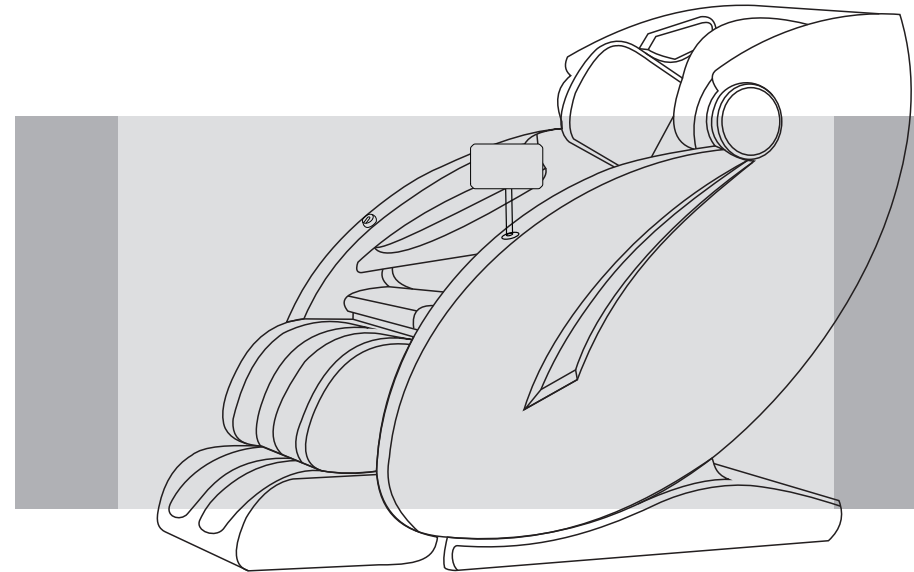

Before operating this unit, please read these instructions completely.

Contents

Before Use

IMPORTANT SAFETY INSTRUCTIONS	1
Safety Precautions	2-3
FCC Radiation Exposure Statement.....	4
Chair Components	5
Setting up the massage chair	6
Chair Installation	7-8
Preparation before Use	9-10

How to Use

Controller	11
How to Use.....	12-17

Q&A / Important

Cleaning and maintenance	18
Troubleshooting	19
Grounding Instructions.....	20
Chair Specifications.....	21

Thank you for purchasing this Massage Chair.
 Before using your massage chair, please read the contents of this instruction manual and refer to it when needed.

Chair Specifications

Description	Specifications
Model No.	OE100/OE101/OE102
Rated Voltage	110-120V~
Rated Frequency	50-60Hz
Rated Power Consumption	110W
Rated Time	15 minutes
Dimensions(L x W x H)	Upright: 54.3*29.1*42.5 inch
	Reclined: 66.9*29.1*33.5 inch
Weight	Gross Weight: Approx.183 lbs
	Net Weight: Approx.149.9 lbs
Length of Wire	Controller wire: 29.5 inch
	Power supply wire: 70.9 inch
Usage Condition	Environment temperature: 32°F~95°F
	Contrasting humidity: 20-80RH
Storage Condition	Storage temperature: 23°F~95°F
	Storage humidity: 20-80RH
Safety Feature	Equipped with overheated and power
Maximum body weight of user	220 lbs

Grounding Instructions

This product must be grounded. If it should malfunction or break down, grounding provides a path of least resistance for the electric current to reduce the risk of electric shock. This product is equipped with a cord with an equipment-grounding conductor and a grounding plug. The plug must be plugged into an appropriate outlet that is properly installed and grounded in accordance with all local codes and ordinances.

Danger-Improper connection of the equipment-grounding conductor can result in a risk of electric shock. Check with a qualified electrician or service technician if the product will not fit the outlet, have a proper outlet installed by a qualified electrician.

This product is for use on a nominal 110V circuit and has grounding plug that looks like that plug illustrated below. Make sure that the product is connected to an outlet having the same configuration as the plug. No adapter should be used with this product.

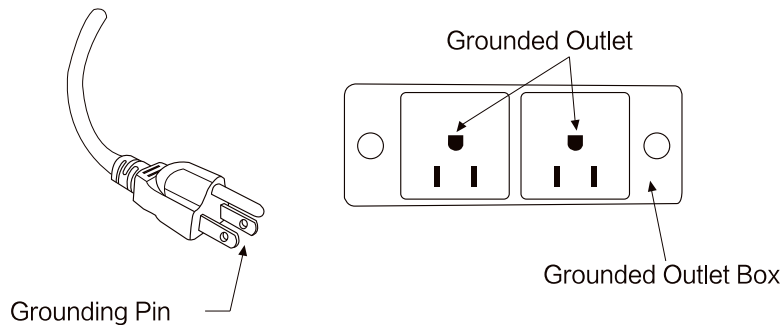

IMPORTANT SAFETY INSTRUCTIONS

When using an electrical appliance, basic precautions should always be followed, including the following:

Read all instructions before using (this appliance).

DANGER To reduce the risk of electric shock:

- Always unplug this appliance from the electrical outlet immediately after using and before cleaning.
- Never use pins or other metallic fasteners with this appliance.
- Carefully examine the covering before each use. Discard the appliance if the covering shows any sign of deterioration, such as checking, blistering, or cracking.

WARNING To reduce the risks of burns, fire, electric shock or injury to persons:

- An appliance should never be left unattended when plugged in. Unplug from outlet when not in use, and before putting on or taking off parts.
- Close supervision is necessary when this appliance is used by, on, or near children, invalids, or disabled persons.
- Use this appliance only for its intended use as described in this manual. Do not use attachments not recommended by the manufacturer.
- Never operate this appliance if it has a damaged cord or plug, if it is not working properly, if it has been dropped or damaged, or dropped into water. Return the appliance to a service center for examination and repair.
- Do not carry this appliance by supply cord or use cord as a handle.
- Keep the cord away from heated surfaces.
- Never operate the appliance with the air openings blocked. Keep the air openings free of lint, hair, and the like.
- Never drop or insert any object into any opening.
- Do not use outdoors.
- Do not operate where aerosol (spray) products are being used or where oxygen is being administered.
- To disconnect, turn all controls to the off position, then remove plug from outlet.
- Keep children away from extended foot support.
- Connect this appliance to a properly grounded outlet only. See Grounding Instructions.
- Use heated surfaces carefully. May cause serious burns. Do not use over insensitive skin areas or in the presence of poor circulation. The unattended use of heat by children or incapacitated persons may be dangerous.
- Do not operate under blanket or pillow. Excessive heating can occur and cause fire, electric shock, or injury to persons.

SAVE THESE INSTRUCTIONS

Safety Precautions

When using the massage chair, basic precautions should always be followed to reduce the risk of electric shock, burns, fire or injury to persons. Please read the following precautions before using the massage chair.

- Make sure the power plug is securely inserted into a proper electrical outlet to reduce the risk of short-circuit and fire.
- It is highly recommended that a surge protector is used to prevent from damage.
- DO NOT use the massage chair in areas where the humidity is high such as sauna steam rooms, pools, bathrooms, AC or heating vents, etc.
- DO NOT use the massage chair outdoors and avoid areas with direct sunlight.
- If the chair is not being used, turn the power switch to the OFF position and unplug the massage chair from the electrical outlet to prevent any damages to the chair when there are power outages/surges that may cause serious damage.
- Never plug/unplug the power cord plug socket with wet hands.
- Close and continuous supervision is necessary when the massage chair is used by, on or near children or disabled persons.
- No more than one person should use the massage chair at the same time.
- The massage chair is intended for use as described in the Instruction Manual. Do not use any attachments other than those recommended by the manufacturer.
- DO NOT attempt to stand or sit on the backrest, armrest or footrest in order to prevent accident, injury or damage to the chair.
- Avoid falling asleep while using the massage chair.
- Always keep the massage chair clean, and never insert any objects into or around the gaps of the massage chair.
- DO NOT move the massage chair by pulling on the power supply cord.
- Make sure there are no children, pets or other obstacles behind or underneath the massage chair.
- If you find any rips or tears in the fabric of the massage chair, contact the service department and stop using the chair immediately.
- This massage chair is designed for household use and should not be used in non-residential settings.

Troubleshooting

This page summarizes the most common problems you could encounter with the product. If you are unable to solve the problem with the information below, contact service center immediately.

If the problem encountered is not listed, please try the following suggestions:

1. Turn off the product and unplug it.
2. Wait for 60 minutes.
3. Plug the product back to the recommended outlet and restart.
4. If the problem persists, contact the authorized service center.

Problem	Possible Cause	Suggestion
The product does not work	The product is not plugged in properly.	Ensure the voltage on the product corresponds to the local mains voltage and then plug in again. Make sure the outlet is properly working.
The product stopped working	The product has just finished its auto timer session and has automatically switched to standby mode.	If you want another session, press the Power button again.
The product stopped working	You may have used the product continuously for 45 minutes where the over heat protection has been activated.	Unplug the product and let it cool down for 60 minutes before you use it again.
The product does not work	An excessive load has been applied on the product.	Reduce the excessive load and start again.
The product is abnormally warm	The product is likely to be overused.	Unplug the product and let it cool down before using it again.
Noise can be heard from the product	Noise is made by the mechanical parts of the product.	This is normal and does not mean that the product is faulty.

Cleaning and maintenance

1. Cleaning of the synthetic leather

Wipe the synthetic leather with a soft dry cloth.

- Do not clean the product with chemicals such as thinners, gasoline and alcohol.
- When using a leather maintenance product (cleaning cloth) sold on the market, follow its directions for use.
- If the synthetic leather is very dirty, wipe it with the method below.

- ① Put a piece of soft cloth into water or 3% to 5% neutral detergent contained hot water and wring it out.
- ② Wipe surface of the synthetic leather with the soft cloth.
- ③ Wipe the detergent with a piece of cloth once soaked in clean water and wrung out.
- ④ Wipe with a piece of wrung soft cloth.
- ⑤ Have the synthetic leather take natural air drying.

- If it is difficult to remove the stains on the synthetic leather, soak a piece of melamine foam bought from the market into a neutral detergent and use it wipe the product.
- Do not dry the surface by a hair drier.
- Surface of the synthetic leather may be dyed by fabric colors; therefore, be careful when wiping the product with denim or colored cloth.
- Synthetic leather may discolor, so the position in contact with the hair dye used should be covered by a towel.

2. Cleaning of the plastic parts

- 1) Put a piece of soft cloth into water or neutral detergent contained hot water, wring it out and wipe the plastic parts.
- Do not clean the product with chemicals such as thinners, gasoline and alcohol.
- 2) Wipe with a piece of cloth once soaked in clean water and wrung out.
- Wring the cloth out before using it to wipe the remote controller.
- 3) Have the plastic parts take natural air drying.

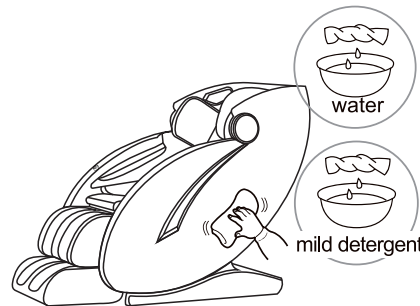
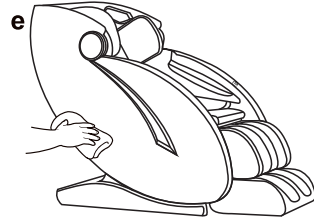

Safety Precautions

- Please consult your doctor if you are in doubt as to whether or not you should use this massage chair.
- Please consult a doctor before using the massage chair if you are pregnant, undergoing any medical treatment, using a medical electronic device such as a pacemaker, or are experiencing any of the following: malignant tumor, heart disease, back pain, abnormal or curved back bone, osteoporosis or acute illness.
- If you experience pain while using the massage chair, stop using the chair immediately and consult your doctor.
- Never use a massage function on swollen or inflamed parts of the body.
- DO NOT use the massage chair for more than 30 minutes at a time.
- DO NOT use the massage chair where aerosol(spray) products are being used or where oxygen is being administered.
- This massage chair is a non-professional product designed to provide a comfortable massage and should not be substituted for appropriate medical treatment.
- Never operate the appliance with the air hoses that inflate while they are blocked. Keep the air openings free of lint, hair, and any other obstructions.
- Check the skin which is in contact with the heated area of the appliance frequently to reduce the risk of injury. If the heating pad malfunctions and extreme heat is produced it may cause serious burns.
- Burns may result from improper use. If this is the case immediately shut off the chair and unplug from the outlet.
- Remove all sharp objects from the body and pockets such as keys and pens.
- Keep children away from extended foot support (or other similar parts.)
- DO NOT WET-DO NOT USE PINS.
- NEVER REMOVE COVER.

Caution

The user's weight is usually limited to 220 lbs.

For those who are weighing 220 lbs or more, the product operations may make more noise and the fabric cover may wear out faster.

FCC Radiation Exposure Statement

FCC Radiation Exposure Statement: (mobile device)

This equipment complies with FCC radiation exposure limits set forth for an uncontrolled environment. In order to avoid the possibility of exceeding the FCC radio frequency exposure limits, Human proximity to the antenna shall not be less than 20cm (8 inches) during normal operation.

FCC STATEMENT

1. This device complies with Part 15 of the FCC Rules. Operation is subject to the following two conditions:

- (1) This device may not cause harmful interference, and
- (2) This device must accept any interference received, including interference that may cause undesired operation.

2. Changes or modifications not expressly approved by the party responsible for compliance could void the user's authority to operate the equipment.

This equipment has been tested and found to comply with the limits for a Class B digital device, pursuant to part 15 of the FCC Rules. These limits are designed to provide reasonable protection against harmful interference in a residential installation. This equipment generates, uses and can radiate radio frequency energy and, if not installed and used in accordance with the instructions, may cause harmful interference to radio communications. However, there is no guarantee that interference will not occur in a particular installation. If this equipment does cause harmful interference to radio or television reception, which can be determined by turning the equipment off and on, the user is encouraged to try to correct the interference by one or more of the following measures:

- Reorient or relocate the receiving antenna.
- Increase the separation between the equipment and receiver.
- Connect the equipment into an outlet on a circuit different from that to which the receiver is connected.
- Consult the dealer or an experienced radio/ TV technician for help.

How to Use

15.Back Rise :

Long press this key to adjust the backrest of the massage chair to rise up.

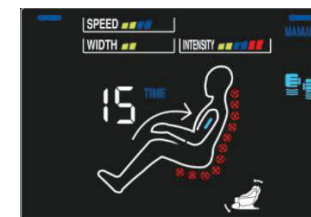

16.Back Drop

Long press this key to adjust the backrest of the massage chair to descend.

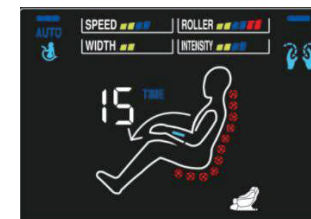

17.Foot Roller

Press this key to turn on the foot roller massage function.

Press this key again to adjust the massage intensity to 3 levels.

Press this key for the fifth time to turn off the foot massage function

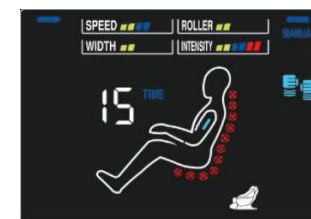

18.Heating

Press this key to activate the waist and calf hot compress function.

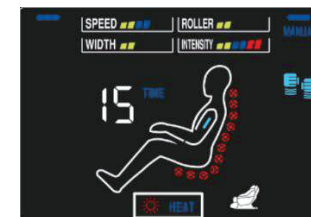

How to Use

11. Timing

Press this key to adjust the massage duration.

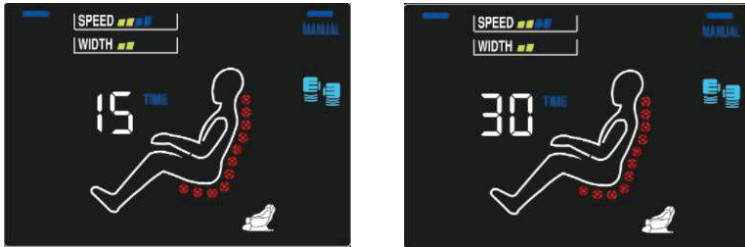

12. Manual Pressure

Press this key to switch between shoulder, arm, leg, and full body airbag massage.

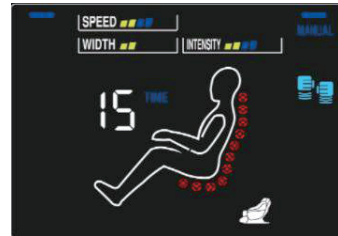

13. Air pressure intensity

In manual massage mode, press this key to switch to 3 levels of gear air pressure.

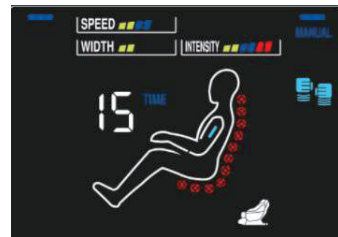

14. Zero Gravity

Press this key to turn on zero gravity mode, press this key again to turn off zero gravity mode.

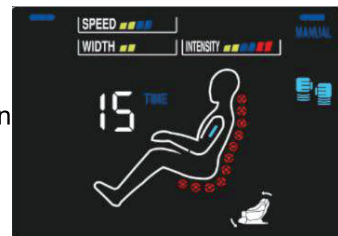

Chair Components

Front

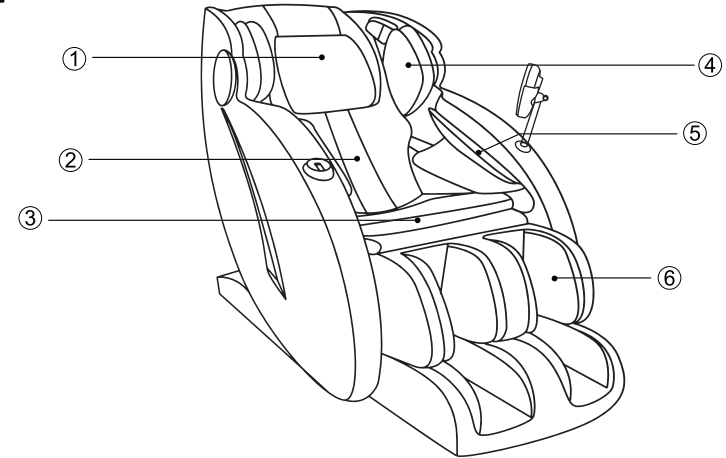

- ① Pillow Pad
- ② Backrest Pad
- ③ Seat Cushion
- ④ Shoulder side massage section
- ⑤ Hand and arm massage section
- ⑥ Legrest

Bluetooth Speaker

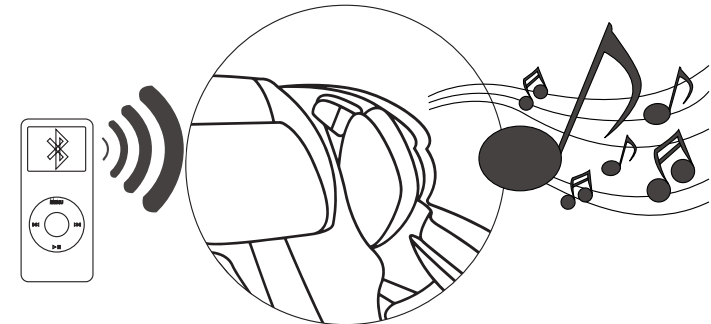

NOTE:

The bluetooth speaker can only connects with one bluetooth device at a time. Please turn off your bluetooth device after using so that other users can enjoy it as well.

Setting up the massage chair

1. Installation Position.

- The chair provides a slide forward function that user can save space and place it very close to the wall.

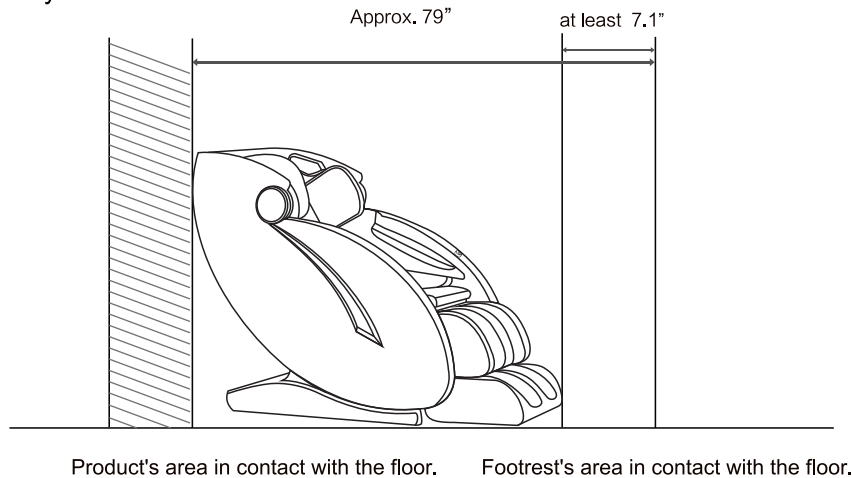

- Do not expose the massage lounger to direct sunlight or high temperatures, such as in front of heating sources, because this can cause discoloration or hardening of the synthetic leather.
- Place the unit on a mat to prevent floor damage.
- When placing a mat under the unit, the size of the mat should be sufficient (at least 71" x 35") to cover the areas where the unit touches and where the legrest could touch the floor, as shown in the diagram on the above.
- Install the unit near a power outlet.

How to Use

8.Up

Long press this key to move the massage head upwards, release it to stop moving the massage head.

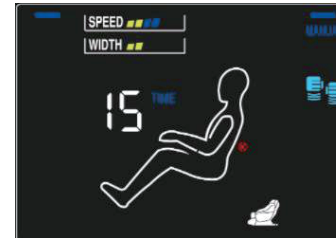

9.Down

Long press this key to move the massage head down wards, release it to stop moving the massage head.

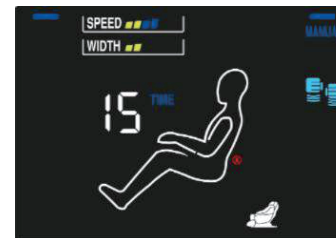

10.Pause

Press this key to pause all massage functions, press this key again to start the massage.

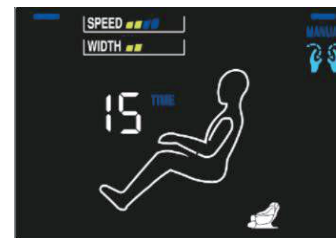

How to Use

5.Speed

In manual massage mode,press this key to adjust the massage head to 3 levels of force.

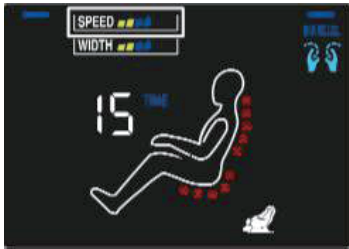

6.Width

Press this key to switch between 3 levels of massage width.

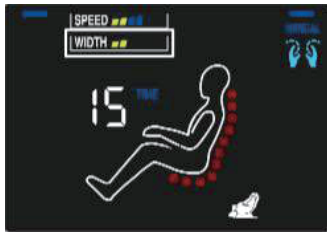

7.Whole&Part

In manual massage mode,press this key to switch between partial and full body massage.

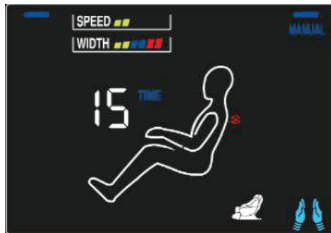

Part 1

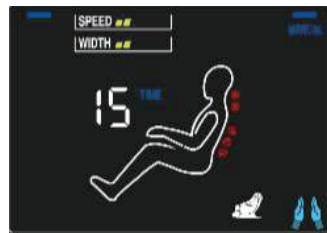

Part 2

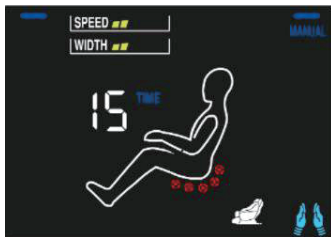

Part 3

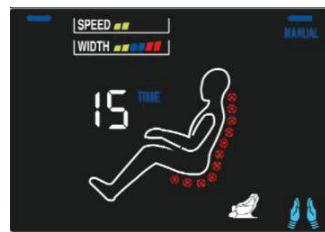

Whole

Chair Installation

Step 1: Preparation before Installing.

1. Remove all components of the chair from the cardboard box
2. Before installing, please check all the parts according to the following list.

NO.	Part List	Qty.
1	Main Unit	1
2	Legrest	1
3	Bracket	1
4	Controller	1
5	Screw	2
6	Latch	2

Chair Installation

Before use note

Before use
Install a foot massager

1

Remove the foot massager from the massage chair.

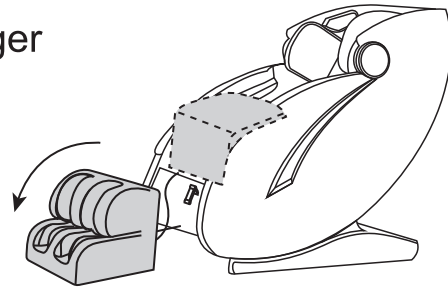

2 Connect the foot massager to the massage chair with screws and nuts.

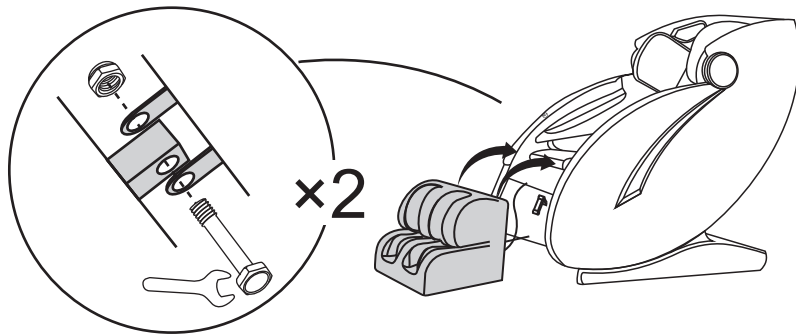

3

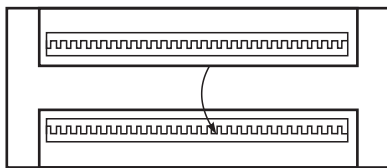

Secure the leg zipper and massage chair zipper

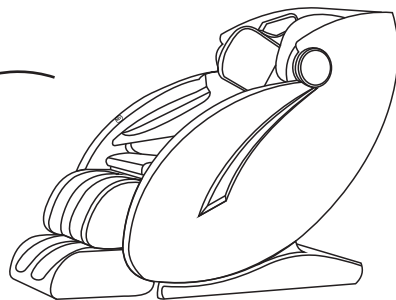

How to Use

3.Auto Pressure

Press this key to turn on or off the automatic air pressure function.



Auto Pressure

4.Manual Massage

Press this key to switch between 6 manual massage modes.

- Knead
- Beat
- Knock
- Finger press
- Knead Tap
- Knead Pound

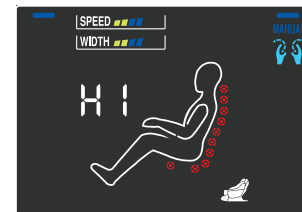

Knead



Beat



Knock



Finger press



Knead Tap



Knead Pound

How to Use

1. Power On/Off(Power Control Button)

Press this button to activate the massage chair. The massage chair is undergoing a body shape test. Please place your head and shoulders tightly against the backrest of the massage chair. After the test is completed, the massage chair will start working.

Press and hold this button again. The massage function will stop. The chair will return to their original positions.

2.Auto(Automatic)

There are 18 automatic massage modes, of which 5 are selected. If you are not satisfied with the selected mode, you can press the **Auto Mode** button to switch to the other 13 automatic modes

- **Leisure**: Press this key to activate the leisure massage mode.
- **Fatigue**: Press this key to activate the fatigue massage mode.
- **Realx Muscles**: Press this key to activate the realx muscles massage mode.
- **Pain Relief**: Press this key to activate the pain relief massage mode.
- **Sleep**: Press this key to activate the sleep massage mode.

Note :In AUTO massage mode , you CANNOT adjust massage speed , roller and width except intensity. You can switch to manual mode for adjustment accordingly.

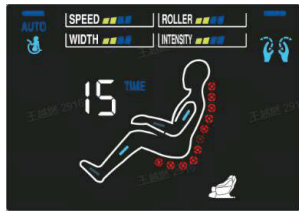

Leisure

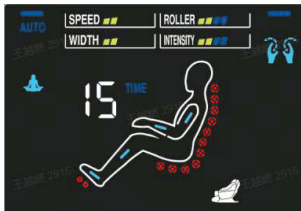

Fatigue

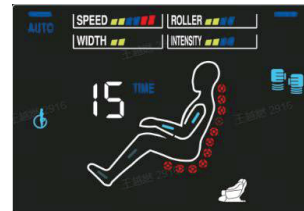

Relax Muscles

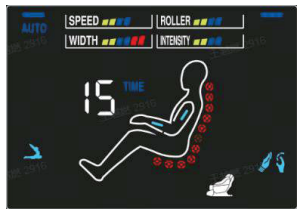

Pain Relief

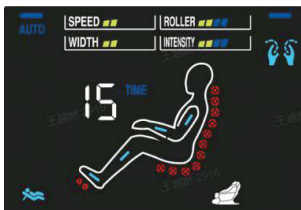

Sleep



Auto Mode

Preparation before Use

1. Check the space around the product.

Make sure there is no person, pet, or other object close to the product.

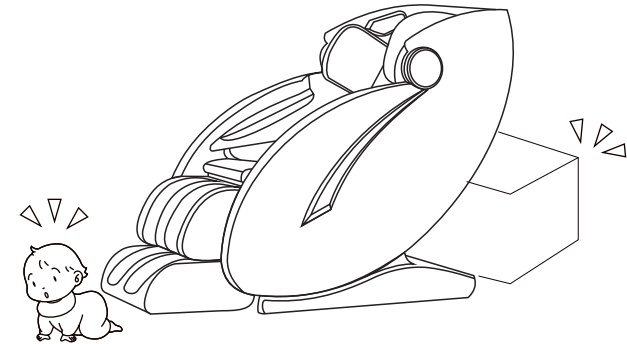

2. Make sure there is no foreign matter in the seams of the product.

- Before sitting on the product, make sure there is no foreign matter between any two parts of it.
- Do not put hands, arms or head between the backrest and the back cover.
- Do not put pets on the product (such as its back cover, backrest and armrests).

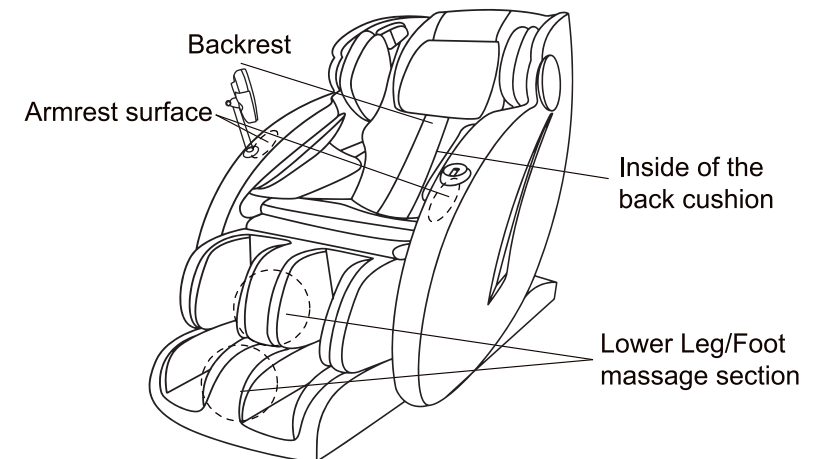

Preparation before Use

3. Power on the product

- ① Push the power connector into the appliance inlet till the end.
- ② Insert the power plug into the power outlet till the end.
- ③ Turn the switch to "I" position

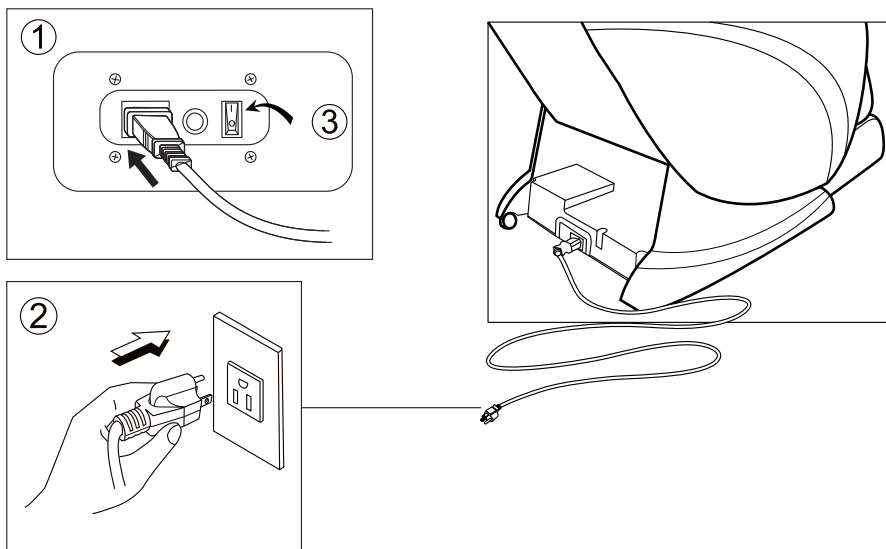

4. Make sure the massage rollers are retracted.

If they are not, press ON button to return them to the retracting position.

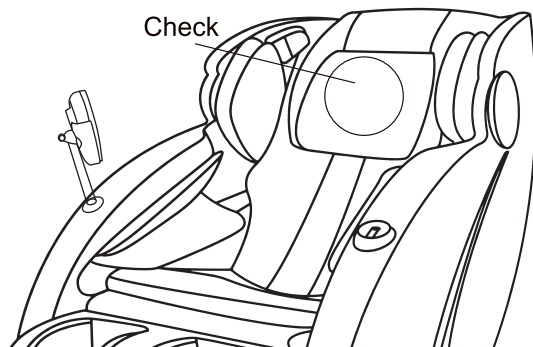

Controller

1. Shortcut keys

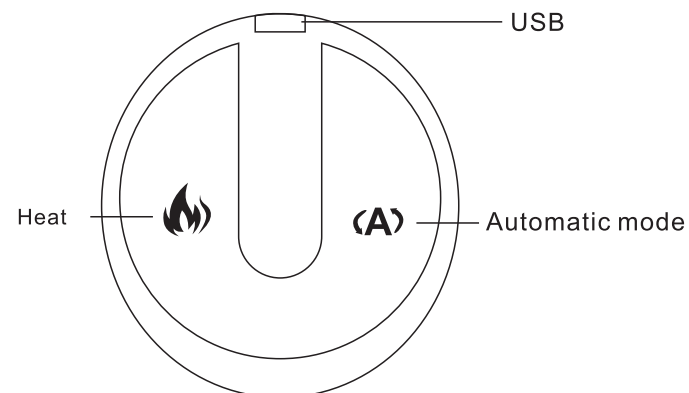

Heat: Tap the heating icon to activate heating function for waist and calf compress function.

Automatic mode: Tap the "A" icon to switch to automatic massage mode.

USB: Connect the USB port for charging the phone.

2. Functional controller

