

FlexiSpot

2-IN-1 TREADMILL USER MANUAL

Model: WPS01B / WPS01P

Note:

Before setup and operation, please read this user manual carefully and keep this manual for future reference.

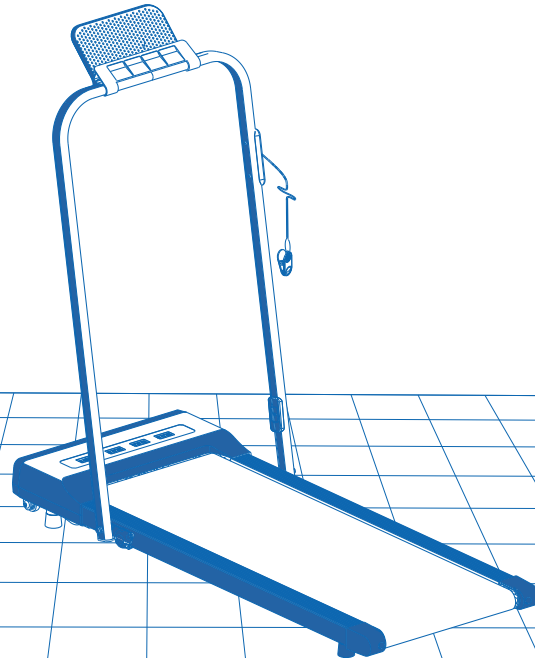

TABLE OF CONTENTS

1. IMPORTANT SAFETY INSTRUCTIONS-----	Page 1
2. SAFETY TIPS-----	Page 2
3. SPECIFICATION-----	Page 5
4. PRODUCT AND ACCESSORIES-----	Page 6
5. TREADMILL PARTS-----	Page 7
6. BEFORE START AND STORAGE-----	Page 8
7. SETUP-----	Page 10
8. SCREEN DISPLAY-----	Page 11
9. REMOTE CONTROL-----	Page 12
10. PRESET PROGRAMS-----	Page 14
11. EMERGENCY STOP-----	Page 15
12. TROUBLESHOOTING GUIDE-----	Page 16
13. CARE AND MAINTENANCE-----	Page 17
14. WARRANTY-----	Page 19

1 IMPORTANT SAFETY INSTRUCTIONS

1. Ensure that you read the manual carefully before attempting to assemble or use the Power Electric Treadmill.
2. The Power Electric Treadmill is designed for indoor use only. It is not to be used outdoors.
3. Do not position the Power Electric Treadmill on a thick carpet as air needs to be able to circulate underneath.
4. Always wear the correct clothing when using the Power Electric Treadmill. Do not wear loose or long clothing as it may get caught in the moving belt.
5. Do not stand on the Power Electric Treadmill belt before operating. Position your feet on either side of the treadmill belt, and as the motor starts, step onto the treadmill. Do not step on the belt if the Power Electric Treadmill is at full speed.
6. Do not allow children or pets near the Power Electric Treadmill when in use.
7. Always unplug the Power Electric Treadmill from the main power supply when not in use.
8. Do not use your treadmill in wet, damp, or dusty areas as this can cause damage to the Power Electric Treadmill.
9. If any part of the electrical cable or plug is loose or becomes worn, do not use the Power Electric Treadmill. Have a qualified electrician inspect the problem.
10. The Power Electric Treadmill is not a toy and is not intended for use by persons (including children) with any physical or mental conditions. The Power Electric Treadmill should not be used by person who has not read and understood the manual.
11. If the user has had any prior medical condition, they should consult a doctor before use.
12. Store the treadmill indoors in a clean and dry area, away from direct sunlight, and ensure the main power switch is off and the power cord is unplugged from the power outlet.

2 SAFETY TIPS

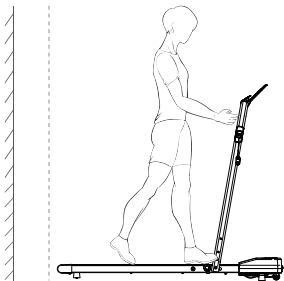

⚠ Keep a rear distance of 39 inches or more.

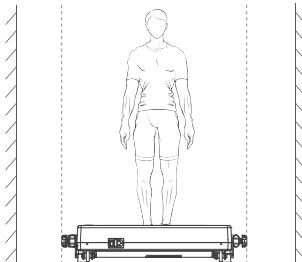

⚠ Keep a distance of 23.6 inches or more on both sides.

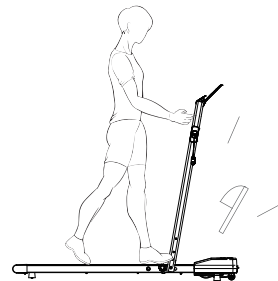

⚠ Wear sneakers when walking or running.

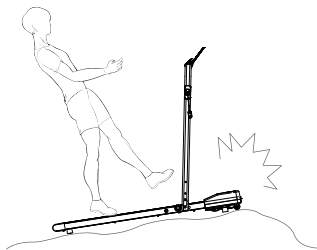

⊗ Do not use the treadmill on an uneven surface.

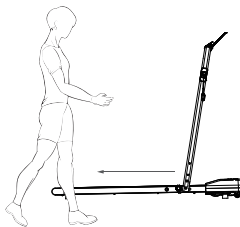

⊗ Do not hop on and off the treadmill when it is in use.



⊗ Do not stand on the treadmill when it is calibrating automatically 4 seconds after starting up.

2 SAFETY TIPS

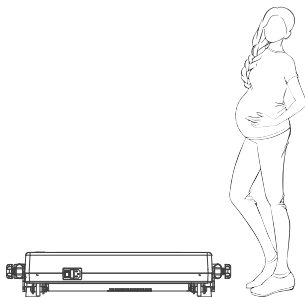

⊗ Elderly and pregnant users must be careful when using the treadmill.

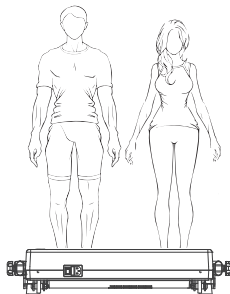

⊗ Ensure only one person uses the treadmill each time.

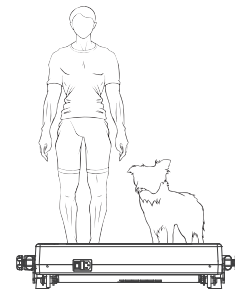

⊗ Do not use with pets.

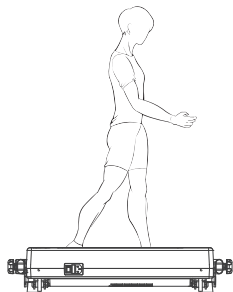

⊗ Do not walk or run sideways on the treadmill.

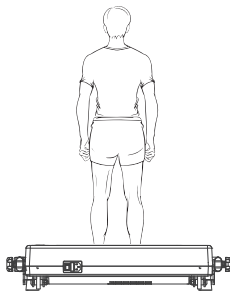

⊗ Do not walk or run backward on the treadmill.

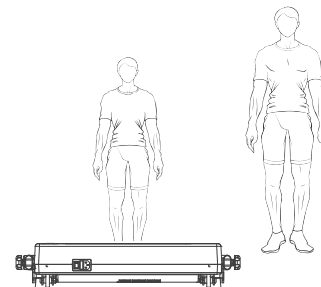

⚠ Children must be supervised when using the treadmill.

2 SAFETY TIPS

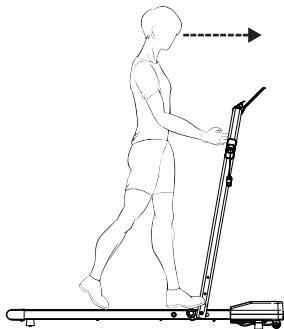

⚠ Look straight ahead to avoid dizziness



⊗ Do not trample on the treadmill.

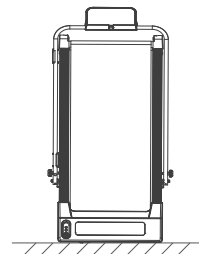

⊗ Do not store the treadmill in an upright position without support.

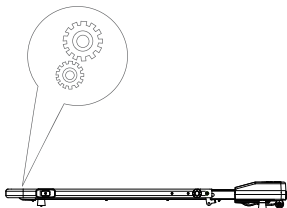

⚠ Ensure clothing and other small items are not caught inside the treadmill.

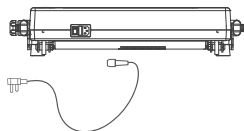

⚠ Unplug the power cord when not in use.

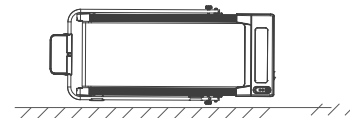

⊗ Do not store the treadmill in a sideways position.

3 SPECIFICATION

Performance Indicators	Detailed Parameters
Max. User Weight	264 lbs
	120 kg
Speed Range (unfolded)	0.6 - 6.2 MPH
Speed Range (folded)	0.6 - 4.0 MPH
Walking Area	40.5 x 15.7 inches
	103 x 40 cm
Product Size (unfolded)	49.2 x 20.1 x 3.1 inches
	125 x 51 x 8 cm
Product Size (folded)	51.2 x 22.4 x 3.1 inches
	130 x 57 x 8 cm
Handrail Height	38.6 inches
	98 cm
Net Weight	45.4 lbs
	20.6 kg
Gross Weight	53.3 lbs
	24.2 kg
Power Rating	745 W
	1.0 HP
Voltage Rating	110 V
Recommended Ages For Use	14 - 60

4 PRODUCT AND ACCESSORIES

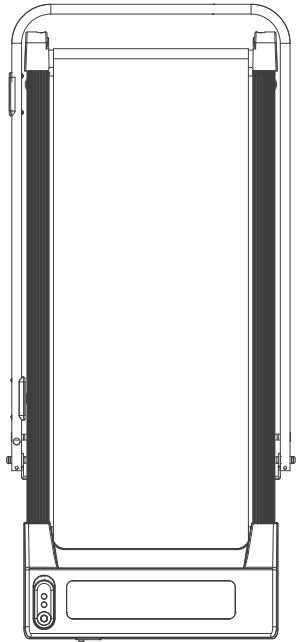

Treadmill x1

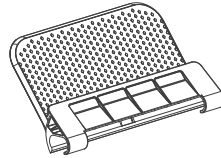

iPad Holder x1

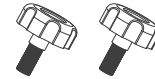

Lock Nuts x2



Allen Key x1

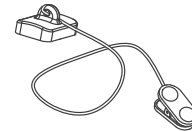

Safety Key x1



Lubricant x1

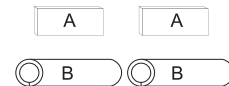

Foam A / B x2

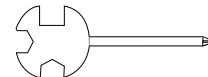

Wrench x1

5 TREADMILL PARTS

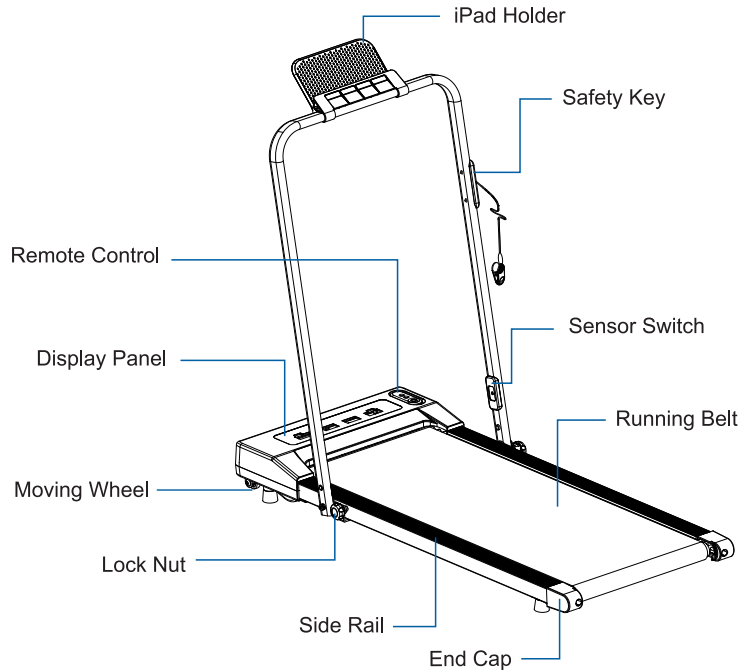

6 BEFORE START AND STORAGE

• Take out appliance from packages

1. Unbox and take out accessory bags.
2. Lift out appliance and place at flat surface.

Attention: 2-3 persons assist is necessary.

3. Its normal that visible welding marks residual on walk belt.

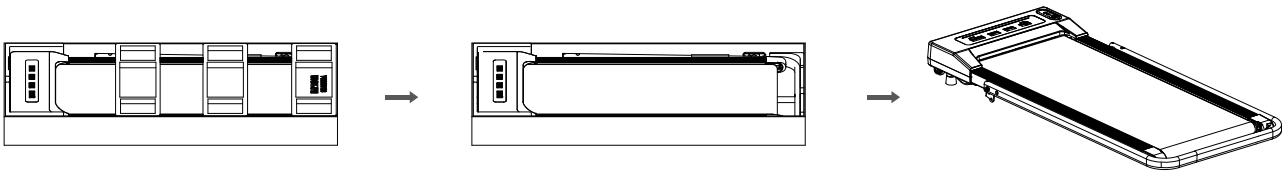

• Transportation

1. Pull out the power cord first before moving the treadmill around.
2. If the customer needs to move the device, first set the tilt angle to zero, then power off and move it. Easy to transport appliance with bottom transportation wheel assists, like as wheelbarrow.

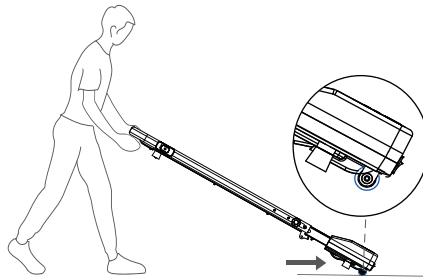

6 BEFORE START AND STORAGE

• Connect the power

1. Choose flat ground to place the Walking Treadmill. Do not place it on thick and soft cushion.
2. Plug in power cord and switch on power rock button, you can hear a Di sound from buzzer, its means the circuit of appliance has connected with power electricity.

Warning: MUST use power cord with comes of package.

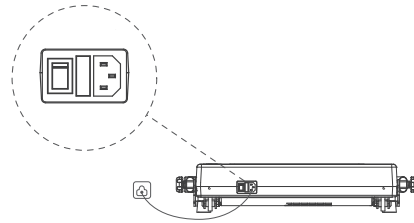
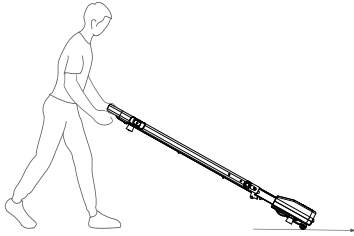

• Storage

Power off appliance and unplug power cord before storage process.

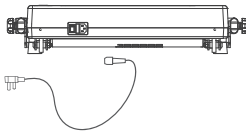

Warning:

Before starting to workout with this product, Please assess your physical condition and perform exercise properly and regularly. Incorrect or excessive training can be harmful to your health, If you feel unwell, Stop exercising immediately and consult with your doctor.

7 SETUP

1. UNFOLD THE TREADMILL

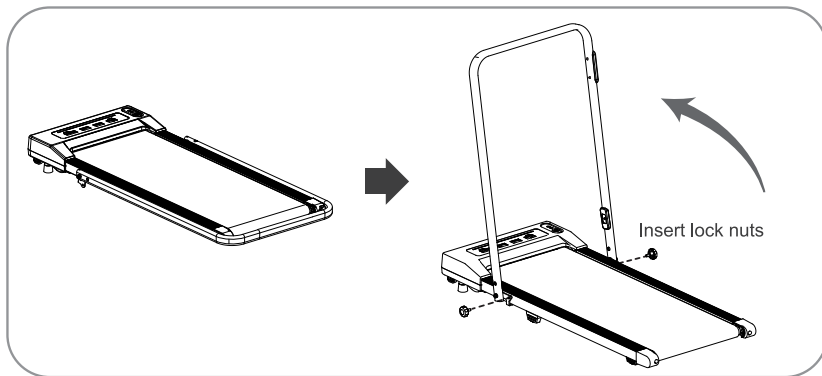

ATTACH THE IPAD HOLDER AND SAFETY KEY

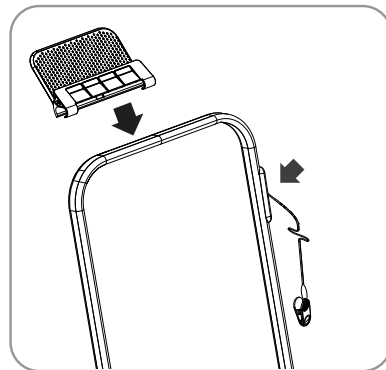

2. FOLD THE TREADMILL

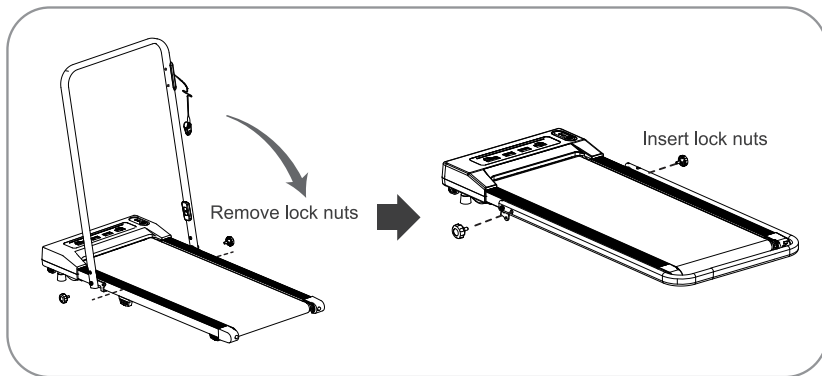

Do not lean against the treadmill with your entire body weight.



Lock nuts can be tightened with the help of the wrench.

8 SCREEN DISPLAY

A digital display showing the time 00:00 in a seven-segment font.

TIME

Display Time
0-99:59

A digital display showing the speed 3.5 in a seven-segment font.

SPEED

Display Speed 0.6-6.2 MPH (treadmill unfolded)
or 0.6-4.0 MPH (treadmill folded)

A digital display showing the distance 00.0 in a seven-segment font.

DISTANCE

Display Distance
0-99.9 miles

A digital display showing the calories 978 in a seven-segment font.

CALORIES

Display Calories
0-999 Kcal

DISPLAY FUNCTIONS:

TIME: Displays your elapsed workout time in minutes and seconds.





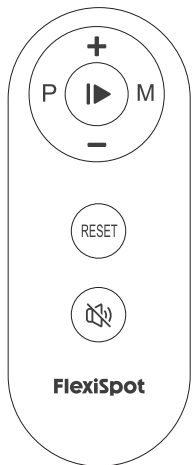

SPEED: Displays the current speed from a minimum of 0.6 MPH to a maximum of 6.2 MPH (treadmill unfolded) or 4.0 MPH (treadmill folded).

DISTANCE: Displays the accumulative distance traveled during workout.

CALORIES: Displays the total calories burned during your workout.

9 REMOTE CONTROL



-  Start or pause the treadmill. You can view your workout data on the screen display.
-  Increase the speed.
-  Decrease the speed.
-  Select the preset training program (P01-P06) before training.
-  Switch the display to set the time/distance/calories.
 - . Time range: 5 - 99 minutes.
 - . Distance range: 0.5 - 65.0 miles.
 - . Calories range: 10 -995 Kcal.
-  Stop the treadmill. "0" is displayed for all 4 display functions.
-  Turn off the beeping sound.

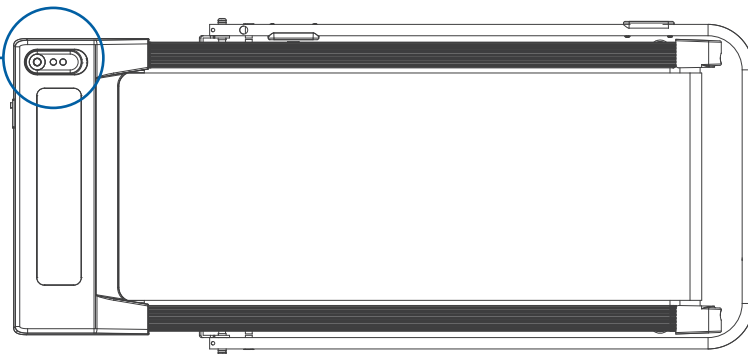

9 REMOTE CONTROL

REMOVE THE INSULATING PULL TAB BEFORE USE

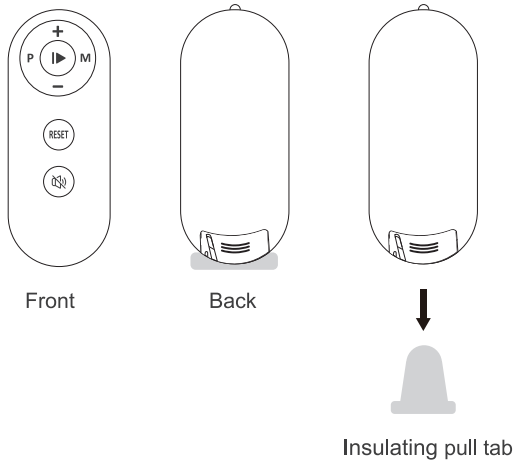

REPLACE BATTERY

STEP 1: Push then pull to remove the battery holder.

STEP 2: Remove the old battery and insert the new battery.

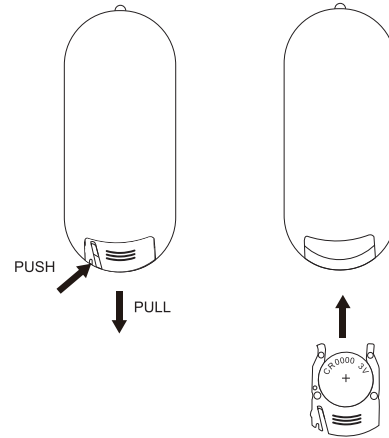

10 PRESET PROGRAMS



P1: Walking Program



P2: Climbing Program 1



P3: Climbing Program 2



P4: Mountain Rd. Program



P5: Interval Program



P6: Jogging Program

PHASE SPEED PROG MPH	1	2	3	4	5	6	7	8	9	10	11	12	13	14	15	16	17	18	19	20
P1	0.6	1.3	1.3	1.3	1.9	1.9	1.9	1.3	1.3	1.3	1.9	1.9	1.9	1.3	1.3	1.3	1.9	1.9	1.9	0.6
P2	0.6	0.6	0.6	1.3	1.3	1.3	1.9	1.9	1.9	2.5	2.5	2.5	3.1	3.1	3.1	3.1	4.0	4.0	4.0	4.0
P3	0.6	0.6	1.3	1.3	1.9	1.9	2.5	2.5	3.1	4.0	4.0	3.1	2.5	2.5	1.9	1.9	1.3	1.3	0.6	0.6
P4	0.6	1.3	1.9	1.3	1.9	2.5	1.9	3.1	4.0	2.5	2.5	1.9	2.5	3.1	1.3	1.9	1.3	0.6	1.3	1.9
P5	1.3	1.3	0.6	0.6	1.9	1.9	0.6	0.6	2.5	2.5	0.6	0.6	3.1	3.1	0.6	0.6	4.0	4.0	0.6	0.6
P6	1.3	1.9	2.5	3.1	3.1	3.1	3.1	3.1	4.0	4.0	4.0	4.0	3.1	3.1	3.1	3.1	3.1	2.5	1.9	1.3

11 EMERGENCY STOP

Before beginning a workout session ensure that the safety key is attached to the buckle seat properly and the safety clip is attached to your clothing securely. If you fall the clip will pull out the safety key from the treadmill console and the running belt will stop immediately to prevent injury.

Reattach the safety key to the treadmill console and press the START button to begin exercising again.

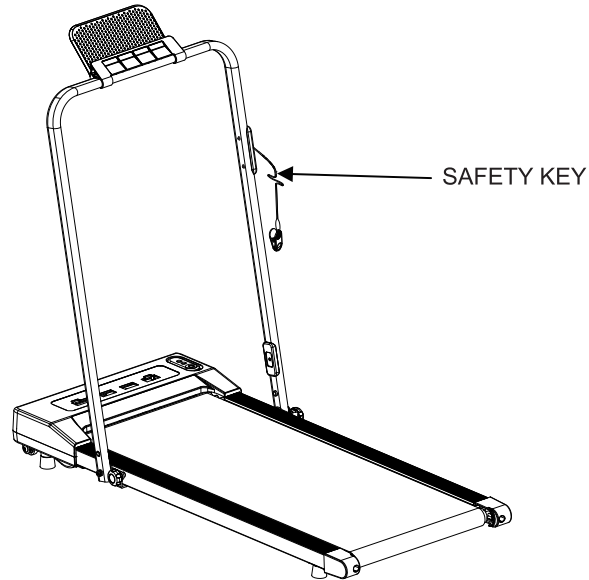

12 TROUBLESHOOTING GUIDE

Problem	Potential Causes	Corrections
The treadmill will not start.	<ol style="list-style-type: none"> 1. The treadmill is not plugged in. 2. The safety key is not attached to the treadmill console properly. 3. The circuit breaker in your house has tripped. 4. The circuit breaker in the treadmill has tripped. 	<ol style="list-style-type: none"> 1. Plug the power cord into a power outlet. 2. Reattach the safety key. 3. Call an electrician to replace the PCB for power supply. 4. Replace a new PCB for motor control.
The running belt slips.	The running belt is not tight enough.	Adjust the running belt's tension.
The running belt does not move when stepped on.	<ol style="list-style-type: none"> 1. The running deck lacks lubrication. 2. The running belt is too tight. 	<ol style="list-style-type: none"> 1. Apply some lubricant. 2. Adjust the running belt's tension.
The running belt is not centered.	The tension of the running belt at the rear conveyor roller is uneven.	Center the running belt.
The running belt stopped.	User weight over 264 lbs (120 kg).	Re-start the power switch, treadmill can be used again for any other people whose weight less than 264 lbs (120 kg).

13 CARE AND MAINTENANCE

A. ADJUSTING THE RUNNING BELT

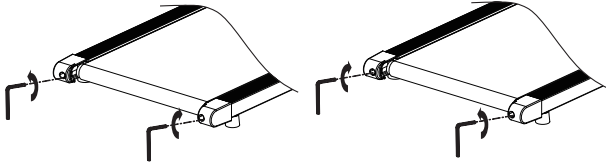
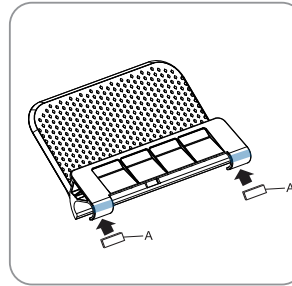

Figure A

Figure B

B. ATTACH FOAM A / B



Attach foam A

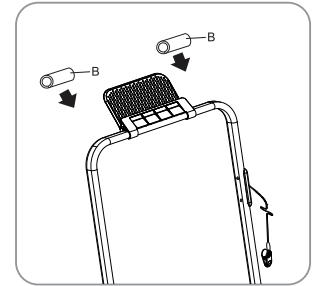

Attach foam B

C. CLEANING

1. Before moving or cleaning your Power Electric Treadmill, unplug it from the main power supply.
2. Always check the wear and tear of components like the V-belt and the running belt to prevent injury.
3. Clean the power switch and console with a soft dry cloth. **DO NOT USE A WET CLOTH ON THESE AREAS.**
4. Clean the Power Electric Treadmill with a damp cloth, avoiding the console. **DO NOT USE HARSH CLEANING AGENTS.**
5. After each workout, ensure that the treadmill is wiped clean.
6. The treadmill can be cleaned with a soft cloth and mild detergent. Do not use abrasives or solvents.
7. Be careful not to get excessive moisture on the display panel as this might damage the unit and create an electrical hazard.

13 CARE AND MAINTENANCE

D. LUBRICATION

1. Lubricating the bottom of the running belt will ensure superior performance and extend the belt's life expectancy. After the first 25 hours of use (or 2 to 3 months), apply some lubricant and repeat following every 50 hours of use (or 5 to 8 months).

2. How to check the running belt for proper lubrication

Lift one side of the running belt and touch the top surface of the running deck. If the surface is slick to the touch, then no further lubrication is required. If the surface is dry to the touch, apply some lubricant.

3. How to apply lubricant

Lift one side of the running belt. Pour some lubricant under the center of the running belt on the top surface of the running deck.

4. Jog on the treadmill at a slow speed for 3 to 5 minutes to distribute the lubricant evenly.

NOTE: DO NOT over-lubricate the running deck. Any excess lubricant that leaks out should be wiped off.



Lubricant

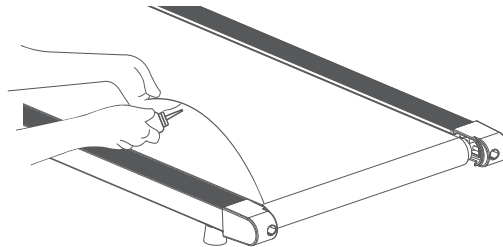

14 WARRANTY

MANUFACTURER'S LIMITED WARRANTY

FlexiSpot warrants to the original purchaser that this product is free from defects in material and workmanship when used for the intended purpose, under the condition that it has been installed and operated in accordance with the provided user manual. FlexiSpot's obligation under this warranty applies to the following:

LENGTH OF WARRANTY FOR EACH COMPONENT

Treadmill frame: 1 year (for home use only)

All other components: 90 days (for home use only)

Exclusions from Warranty Coverage

FlexiSpot does not warrant against, and is not responsible for (and no implied warranty shall be deemed to cover) any product failure, product malfunction, or damages attributable to:

1. Improper installation and/or failure to abide by FlexiSpot's setup guidelines;
2. Use of this product beyond normal home use or in an application for which it was not designed;
3. Cosmetic items such as scratches, dents, or discolorations;
4. Damage caused by normal wear and tear, vandalism, accidents, or by animals;
5. Any act of nature (such as fire, flooding, snow, ice, hurricanes, earthquakes, lightning, or other natural disasters), environmental conditions (such as air pollution, mold, mildew, etc.), or staining from foreign substances (such as dirt, grease, oil, etc.);
6. Normal weathering due to exposure to sunlight, weather, and atmosphere, which can cause colored surfaces to, among other things, flake, chalk, accumulate dirt, or stain;
7. Improper operation, alteration, handling, storage, abuse, or neglect of the products.

FlexiSpot, at its sole discretion, will either repair or replace, free of charge, any part(s) proven to be defective under normal home use. Any repair or replacement shall not extend the original warranty period but shall retain only the remaining portion of the original product's warranty.

This warranty is offered only to the original purchaser and is not transferable. Proof of original purchase is required.

When ordering replacement parts, please have the following information ready:

1. **Order Number**
2. **Description of Parts (adding photos or videos would be helpful)**
3. **Part Number**
4. **Date of Purchase**

Website: www.flexispot.com
Tel: 1-855-585-5618